

Mechanical:

REV.	ECN NO.	DESCRIPTION	DATE	APPD
A	REL		17/07/2008	

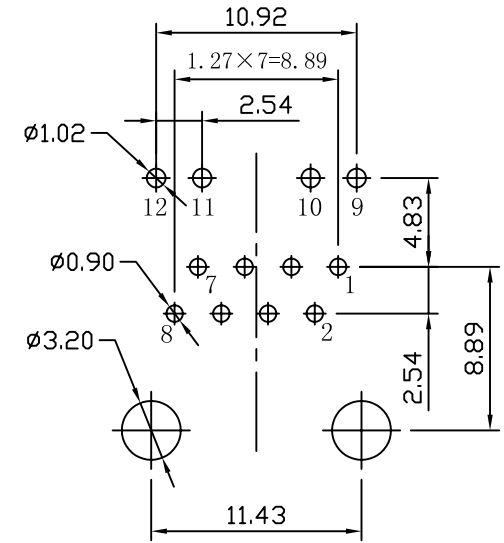

SUGGESTED PCB LAYOUT (TOP VIEW)

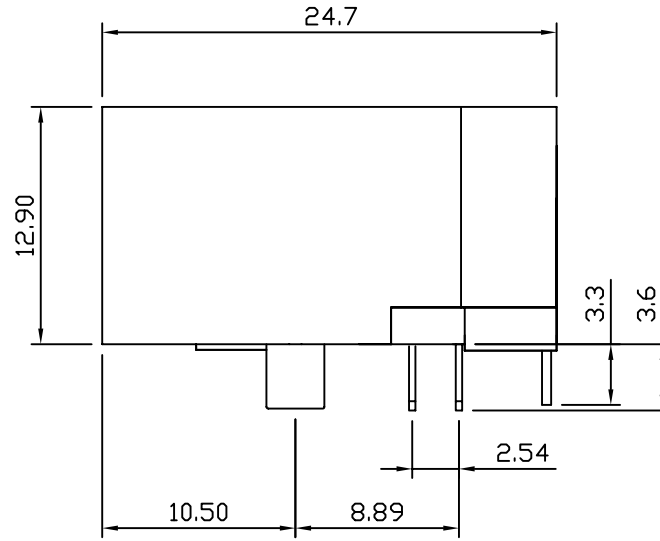
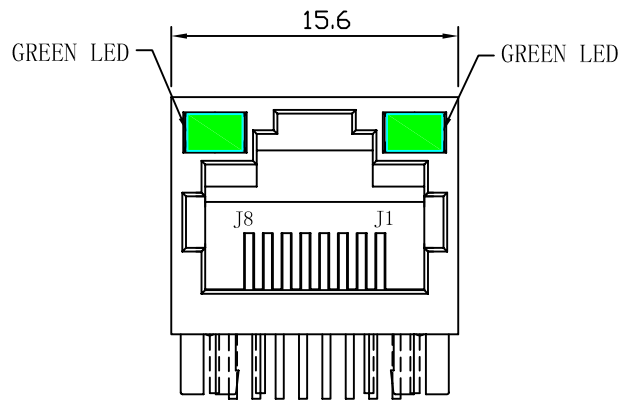
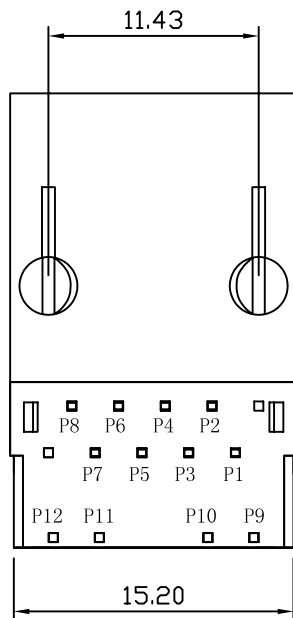

NOTES:

1. Designed to support application, such as SOHO (ADSL modems), LAN-on-Motherboard (LOM), hub and Switches.
2. Meets IEEE 802.3 specification
3. Connector Materials:
 Housing: Thermoplastic UL94V-0
 Contact/Shield: Copper alloy
 Shield plating: Nickel
 Contact plating: Gold 6 micro-inches min. In contact area.
4. Wave solder tip temperature: 265°C Max
 Wave solder tip temperature time: 5 Sec Max



X:X ±0.25	APPD:	LINK-PP INT'L TECHNOLOGY CO., LIMITED
X:XX ±0.20	CHKD:	
X:XXX ±0.05	DR: TOM	TITLE: RJ45 Connector with 10/100 Base-TX Integrated Magnetics
ANGLES ±1°	UNIT: mm	PART NO.: LPJ1014NWNL
	SCALE: 2/1	SHEET: 1/2
	REV: A	DWG NO.: LP08071703

Schematic:

REV.	ECN NO.	DESCRIPTION	DATE	APPD
A	REL		17/07/2008	

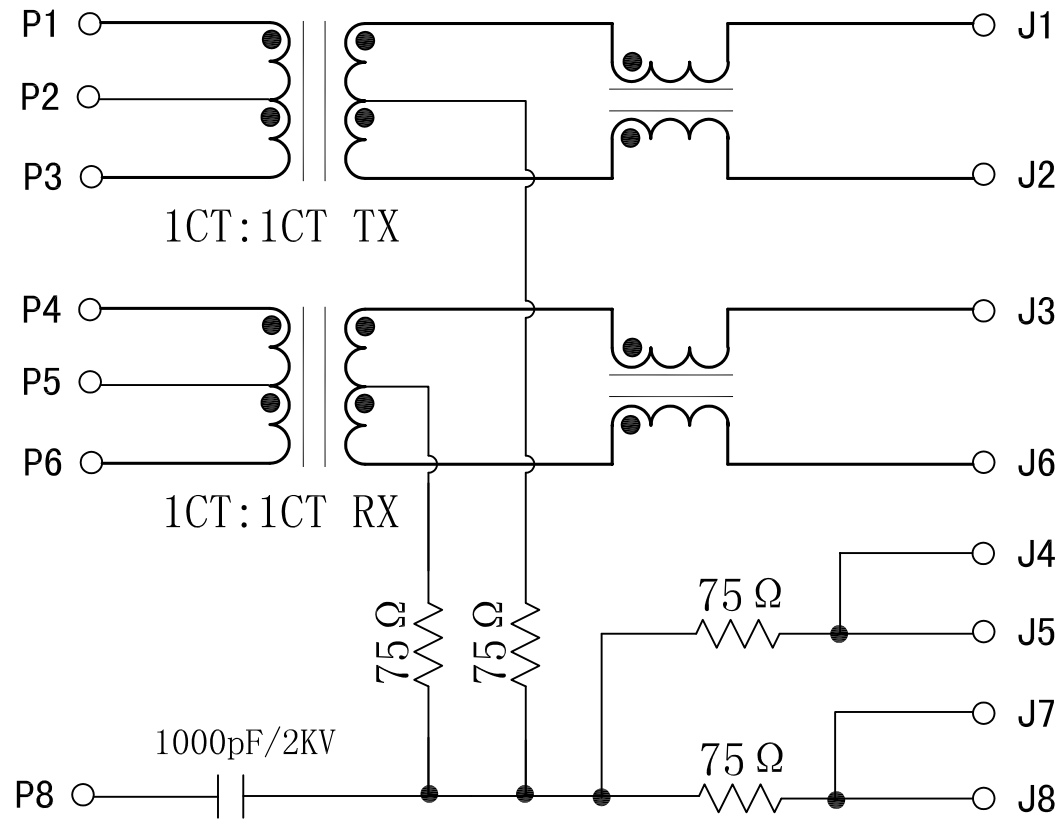

GREEN/LEFT LED

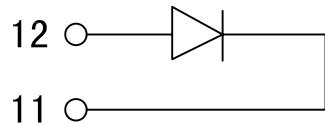

GREEN/RIGHT LED

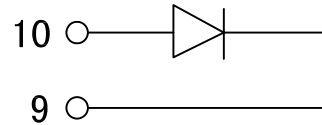

Electrical Specification:

TEST NOTES (25 ± 5°C)

- TR: (100KHz, 100mV);
TX=1CT:1CT ± 3% RX=1CT:1CT ± 3%
- LX: (100KHz, 100mV, 8mA, DC Bias)
PINS: (P1, P3), (P4, P6)=350uH MIN
- HIPOT:
PINS (P1, P2, P3) TO (J1, J2)=1500VAC
PINS (P4, P5, P6) TO (J3, J6)=1500VAC
- INSERTION LOSS:
-1.0dB MAX @ 1.0MHz TO 65MHz
- RETURN LOSS:
-20dB MIN @ 1MHz TO 10MHz
-16dB MIN @ 10MHz TO 30MHz
-12dB MIN @ 30MHz TO 60MHz
-10dB MIN @ 60MHz TO 100MHz
- CROSS TALK:
-40dB MIN @ 1MHz TO 30MHz
-35dB MIN @ 30MHz TO 60MHz
-30dB MIN @ 60MHz TO 100MHz
- COMMON TO COMMON MODE REJECTION:
-30dB MIN @ 1MHz TO 50MHz
-20dB MIN @ 50MHz TO 150MHz
- Operating Temperature: 0°C ~ 70°C.



X:X	±0.25	APPD:	LINK-PP INT'L TECHNOLOGY CO., LIMITED	
X:XX	±0.20	CHKD:	TITLE: RJ45 Connector with 10/100 Base-TX Integrated Magnetics	
X:XXX	±0.05	DR: TOM	PART NO.: LPJ1014NWNL	
ANGLES	±1°	UNIT: mm	DWG NO.: LP08071703	
	SCALE: 2/1	SHEET: 2/2	REV: A	